

# KATALOG STANDARDNĚ VYRÁBĚNÝCH PODKLADOVÝCH SKEL

## TRAPÉZOVÁ HRANA

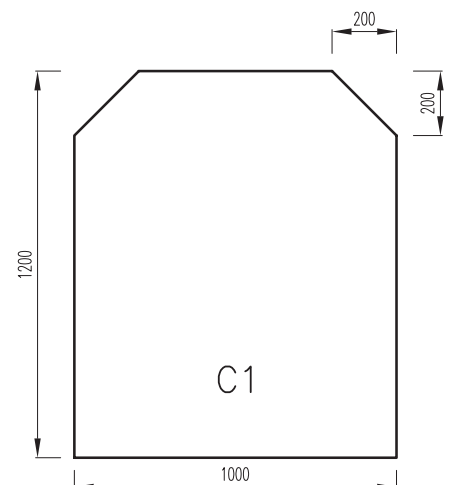
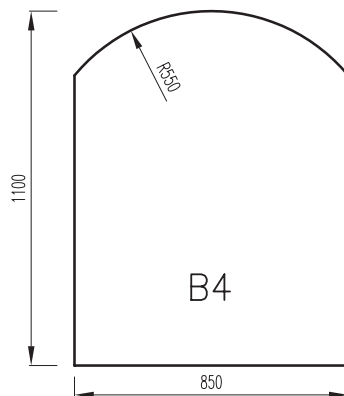
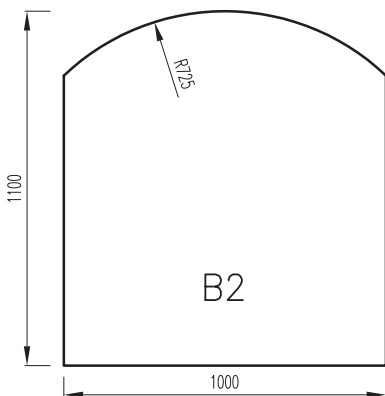
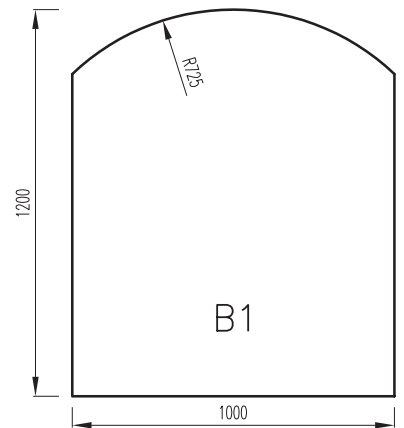
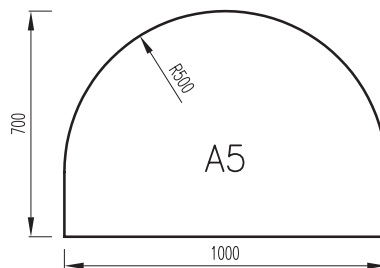
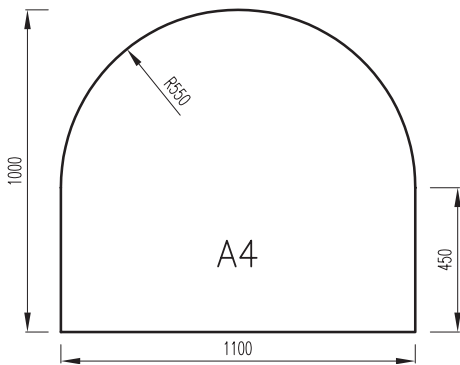
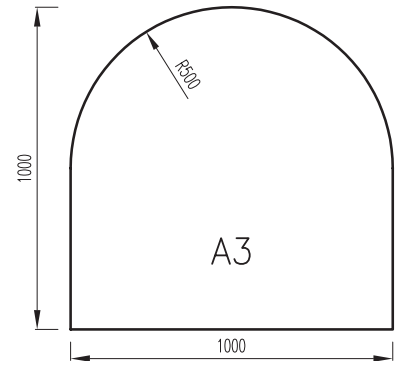
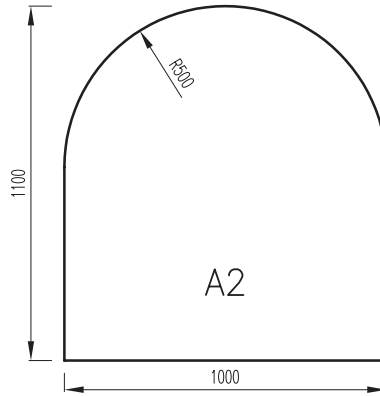
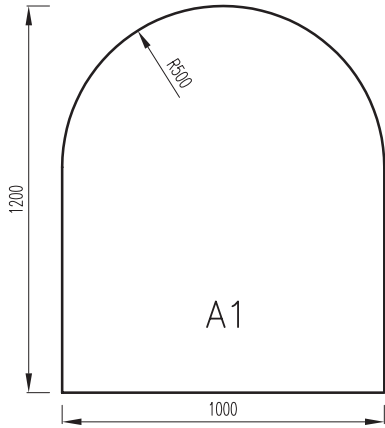

# KATALOG STANDARDNĚ VYRÁBĚNÝCH PODKLADOVÝCH SKEL

## TRAPÉZOVÁ HRANA

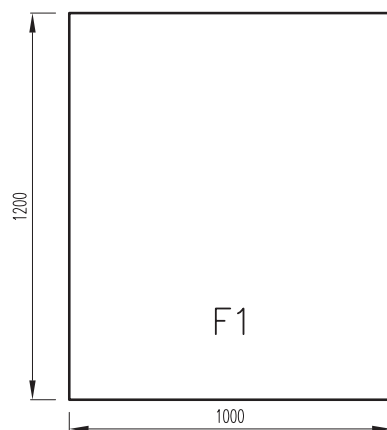
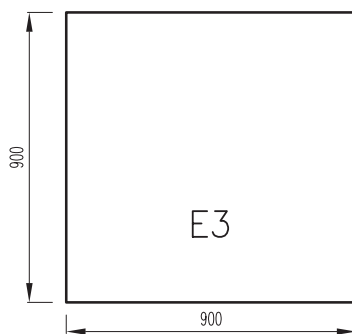
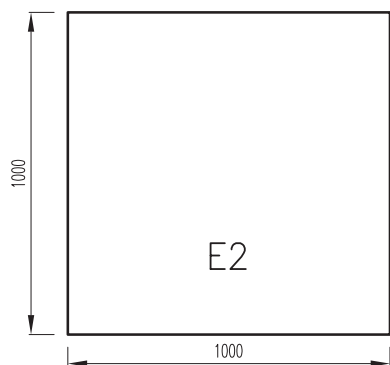
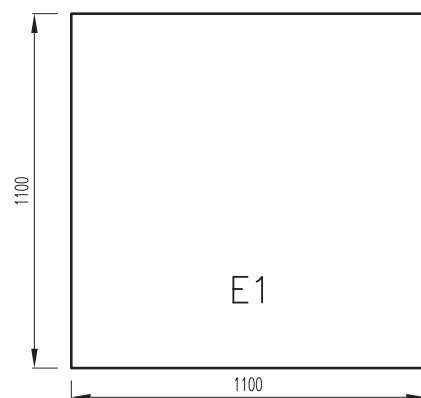
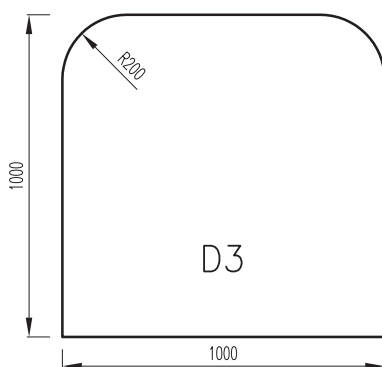
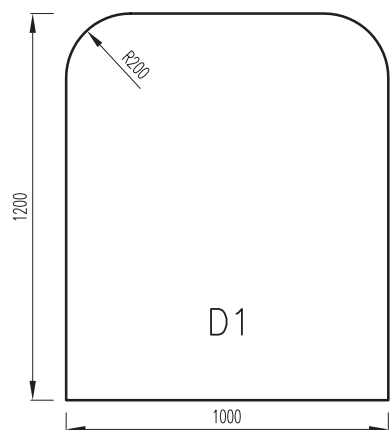
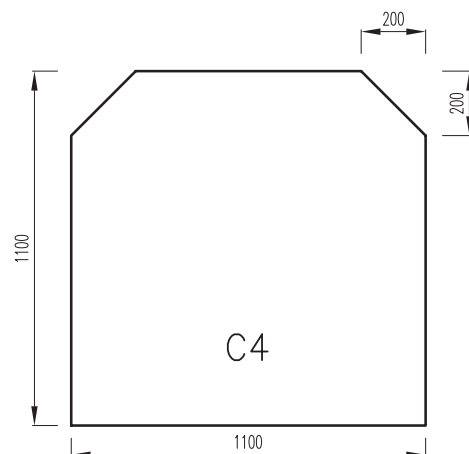
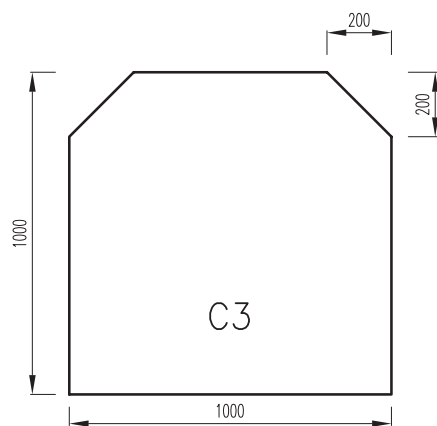
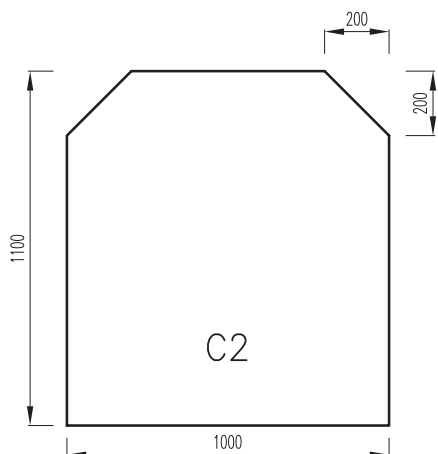

# KATALOG STANDARDNĚ VYRÁBĚNÝCH PODKLADOVÝCH SKEL

## TRAPÉZOVÁ HRANA

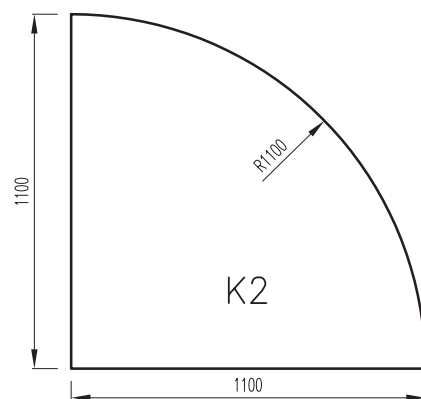
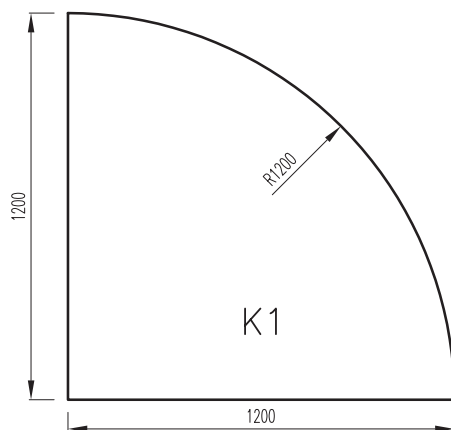
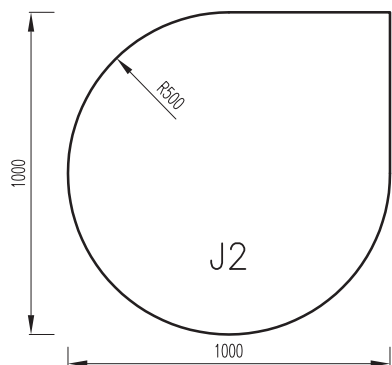
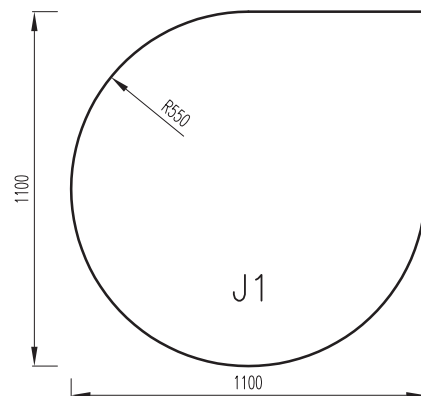
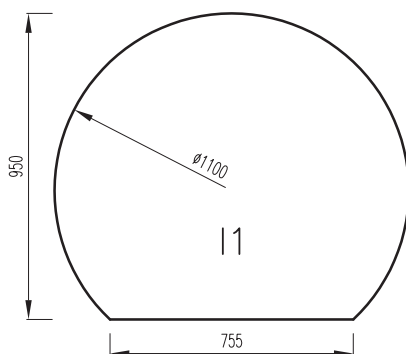
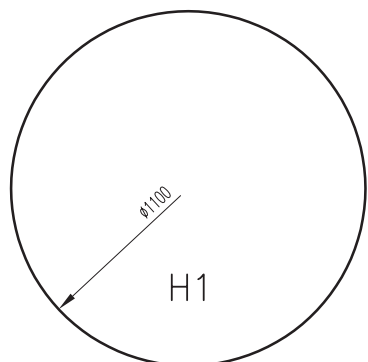
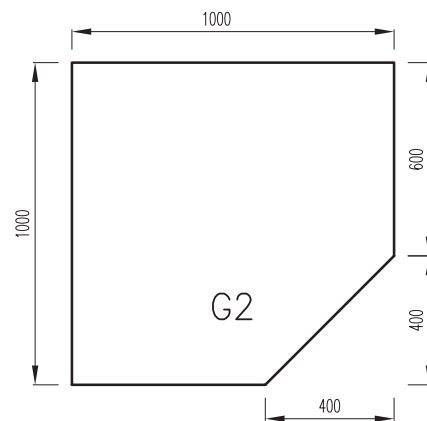
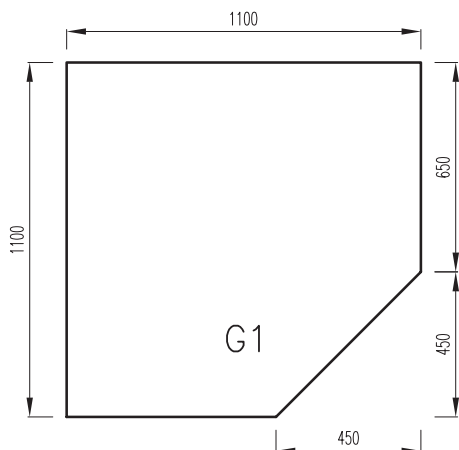
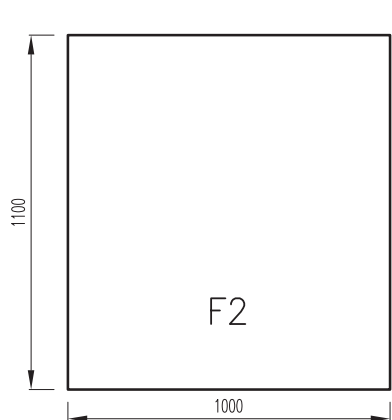

# KATALOG STANDARDNĚ VYRÁBĚNÝCH PODKLADOVÝCH SKEL

## TRAPÉZOVÁ HRANA

